

# Role of *MLH1* methylation in esophageal cancer carcinogenesis and its clinical significance

Jinyun Li<sup>1</sup>  
 Dong Ye<sup>2</sup>  
 Lei Wang<sup>3</sup>  
 Yingying Peng<sup>3</sup>  
 Qun Li<sup>2</sup>  
 Hongxia Deng<sup>2</sup>  
 Chongchang Zhou<sup>2</sup>

<sup>1</sup>Department of Oncology and Hematology, Affiliated Hospital of Ningbo University, <sup>2</sup>Department of Otorhinolaryngology – Head and Neck Surgery, <sup>3</sup>Department of General Surgery, Lihuili Hospital of Ningbo University, Ningbo, Zhejiang, China

**Abstract:** The mutL homolog-1 (*MLH1*) is a DNA mismatch repair gene and has been reported to be frequently methylated in numerous cancers. However, the association between *MLH1* methylation and esophageal cancer (EC), as well as its clinical significance, remains unclear. Hence, we conducted a systematic meta-analysis based on 19 articles (including 1384 ECs, 345 premalignant lesions, and 1244 healthy controls). Our analysis revealed that the frequency of *MLH1* methylation was significantly elevated during EC carcinogenesis. In addition, we observed that *MLH1* promoter methylation was associated with age (odds ratio [OR]=1.79; 95% CI=1.20–2.66), advanced tumor grade (OR=3.7; 95% CI=2.37–5.77), lymph node metastasis (OR=2.65; 95% CI=1.81–3.88), distant metastasis (OR=7.60; 95% CI=1.23–47.19), advanced clinical stage (OR=4.46; 95% CI=2.88–6.91), and poor prognosis in EC patients (hazard ratio =1.64, 95% CI =1.00–2.69). The pooled sensitivity, specificity, and area under the curve of *MLH1* methylation in EC patients versus healthy individuals were 0.15, 0.99, and 0.77, respectively. Our findings indicate that *MLH1* methylation is involved in the carcinogenesis, progression, and metastasis of EC. Moreover, methylated *MLH1* could be a potential diagnostic and prognostic biomarker for EC.

**Keywords:** *MLH1*, methylation, esophageal cancer, carcinogenesis, diagnosis, prognosis

## Introduction

Esophageal cancer (EC) is the eighth most common cancer globally and has the sixth poorest survival rate.<sup>1</sup> The worldwide incidence of EC has been increasing for several decades for reasons that are not entirely clear but may be related to the increasing prevalence of risk factors such as smoking, alcohol intake, and obesity.<sup>2,3</sup> Esophageal squamous cell carcinoma (ESCC) is the predominant histological type worldwide, with the majority of ESCCs occurring in Asia and southeastern Africa.<sup>4</sup> However, in Western Europe and northern America, there is a preponderance of esophageal adenocarcinoma (EAC).<sup>5</sup> Despite the development of adequate treatments, including endoscopic resection, surgical resection, chemotherapy, and radiotherapy, treatment outcomes are far from satisfactory, and the 5-year survival rates are ~15%–25%.<sup>2,6</sup> Due to the insidious early symptoms of EC and the lack of effective screening techniques, most patients are diagnosed in an advanced stage.<sup>7</sup> Therefore, more effective and robust biomarkers are in great demand for the early screening, diagnosis, and prognosis of EC.

EC carcinogenesis is a complex and multifactorial process that includes the accumulation of multiple genetic and epigenetic changes. The precursor lesions for EAC and ESCC are Barrett's esophagus (BE) and dysplasia, respectively. A minority of individuals with precancerous lesions will develop EC through a progression sequence.<sup>8</sup>

Correspondence: Chongchang Zhou  
 Department of Otorhinolaryngology –  
 Head and Neck Surgery, Lihuili Hospital  
 of Ningbo University, 57 Xingning Road,  
 Ningbo, Zhejiang 315040, China  
 Email zhou900709900709@163.com

Encompassing complicated aspects of cancer development, epigenetic modification is considered to have a crucial role in the carcinogenesis of EC.<sup>9</sup> As one of the most important epigenetic alterations, abnormal DNA methylation in the promoter region induces transcriptional silencing of tumor suppressor genes (TSGs) and plays an important role in the progression of several cancers, such as cervical cancer,<sup>10</sup> hepatocellular carcinoma,<sup>11</sup> and head and neck squamous cell carcinoma.<sup>12</sup> In addition, aberrant methylation has been shown to occur early in the progression of precancerous lesions to EC.<sup>13</sup> Moreover, due to precise and convenient methods of detection, DNA methylation has become a noninvasive biomarker for the early detection and diagnosis of cancer.<sup>14</sup>

The mutL homolog-1 (*MLH1*) gene on chromosome 3p22.3 is a key component of the DNA mismatch repair (MMR) pathway, which is a system for recognizing and repairing erroneous insertion, deletion, and misincorporation of bases during DNA replication and is critical for maintaining genomic stability.<sup>15</sup> Inactivation of *MLH1* was reported to be a contributing factor in the initiation and development of gastrointestinal cancer exhibiting high-frequency microsatellite instability.<sup>16,17</sup> Moreover, hypermethylation of the *MLH1* gene promoter was shown to be responsible for the loss of *MLH1* expression in a wide variety of cancers, including lung cancer,<sup>18</sup> colorectal cancer,<sup>19</sup> gastric carcinoma,<sup>20</sup> ovarian cancer,<sup>21</sup> and ECs.<sup>22</sup> However, there were inconsistent results among different studies in assessing the association between *MLH1* promoter methylation and EC. In addition, the role of *MLH1* promoter methylation in EC carcinogenesis and its clinical application for EC diagnosis and prognosis remain less intensely investigated.

Therefore, we carried out a meta-analysis to evaluate the association between *MLH1* promoter methylation and EC risk and its role in EC carcinogenesis. We also determined whether *MLH1* promoter methylation was correlated with clinicopathological characteristics and overall survival (OS) of EC patients. In addition, we assessed the diagnostic value of *MLH1* methylation for EC.

## Materials and methods

### Literature search

PubMed, Google Scholar, Web of Science, Embase, and China National Knowledge Infrastructure, and Wanfang databases were systematically searched to find eligible studies without language restrictions published prior to May 5, 2017. We used the following key words and search terms, individually as well as in various combinations: “*MLH1*,” “*hMLH1*,” “MutL homolog-1,” “methylation,” “DNA methylation,” “promoter methylation,” “esophageal carcinoma,”

“esophagus cancer,” “esophageal tumor,” and “esophageal malignancy.” Furthermore, we manually reviewed the reference lists of the initially identified articles to find more potentially relevant articles.

### Selection criteria

For the studies to be included in the meta-analysis, they had to meet the following criteria: 1) study samples were confirmed by pathology, including ECs, esophageal precancerous lesions (dysplasia or BE), and normal controls; 2) studies that evaluated the methylation frequency of the *MLH1* promoter in the progression of EC carcinogenesis or assessed the association between *MLH1* methylation status and the prognosis of EC patients; 3) studies that were of case-control or cohort designs; and 4) studies that provided sufficient data regarding the methylation frequency of the *MLH1* promoter to enable the calculation of odds ratios (ORs) and 95% CIs or have reported hazard ratios (HRs) and corresponding 95% CIs. If the authors published several articles using the same (or overlapping) data, only the study with the most complete or up-to-date information was included in the meta-analysis.

### Data quality assessment

The quality of studies was assessed according to the Newcastle–Ottawa Scale (NOS) criteria.<sup>23</sup> The NOS evaluation system includes three aspects: 1) subject selection: 0–4 points; 2) comparability of subjects: 0–2 points; and 3) clinical outcome: 0–3 points. NOS scores range from 0 to 9, and a score  $\geq 7$  indicates a good quality. Only studies with scores  $\geq 7$  were included in the analysis.

### Data extraction

Three reviewers (JL, DY, and CCZ) independently extracted relevant data from eligible articles using a standardized form. The following information was extracted: first author, publication year, countries, the ethnicity of subjects, the number of samples, control source, methods to detect *MLH1* methylation, frequency of *MLH1* methylation, HR and the corresponding 95% CI for EC patients with methylated *MLH1*, and clinicopathological characteristics (including age, gender, smoking history, alcohol consumption, tumor location, differentiation grade, tumor stage, lymph node metastasis, distant metastasis, and clinical stage). The three reviewers discussed any discrepancies and eventually reached consensus.

### Statistical analyses

All the analyses were conducted using Stata statistical software, Version 12.0 (Stata Corporation, College Station,

TX, USA). The pooled ORs and corresponding 95% CIs were used to evaluate the strengths of the associations between *MLH1* methylation and the development of EC carcinogenesis, along with clinicopathological features of EC patients. The assessment of potential heterogeneity was quantified based on Cochran's  $Q$ -tests<sup>24</sup> and  $I$ -squared ( $I^2$ ) tests,<sup>25</sup> with statistically significant heterogeneity defined as  $P < 0.05$  or  $I^2 > 50\%$ . A random-effects model<sup>26</sup> was used to calculate the pooled OR when significant heterogeneity was observed; otherwise, a fixed-effects model was applied.<sup>27</sup> Subgroup analyses stratified by ethnicity, histology, control source, detection method, sample size, and publication year were performed to detect potential sources of heterogeneity and lower the between-study heterogeneity. We also performed a sensitivity analysis to assess the robustness of the results and determine the influence of individual studies on the pooled results.<sup>28</sup> Publication bias was quantitatively assessed by using Begg's linear regression tests<sup>29</sup> and Begg's

rank correlation.<sup>30</sup> HRs with 95% CIs were calculated to evaluate the association between *MLH1* methylation and the prognosis of EC patients. Pooled sensitivity and specificity were used to assess the diagnostic power of *MLH1* methylation test for EC. Moreover, to evaluate the overall accuracy and stability of the diagnostic test, the summary receiver operating characteristic (SROC) curve and the area under the SROC curve (AUC) were also calculated.<sup>31</sup> Fagan plot analysis was performed with 25%, 50%, and 75% pretest probability to assess the diagnostic power of *MLH1* methylation in clinical practice for EC diagnosis.<sup>32</sup> All  $P$ -values were two-sided, and a  $P$ -value  $< 0.05$  was considered statistically significant.

## Results

### Study characteristics

Figure 1 presents the strategy for the selection of included studies as well as the final studies included in the meta-analysis.

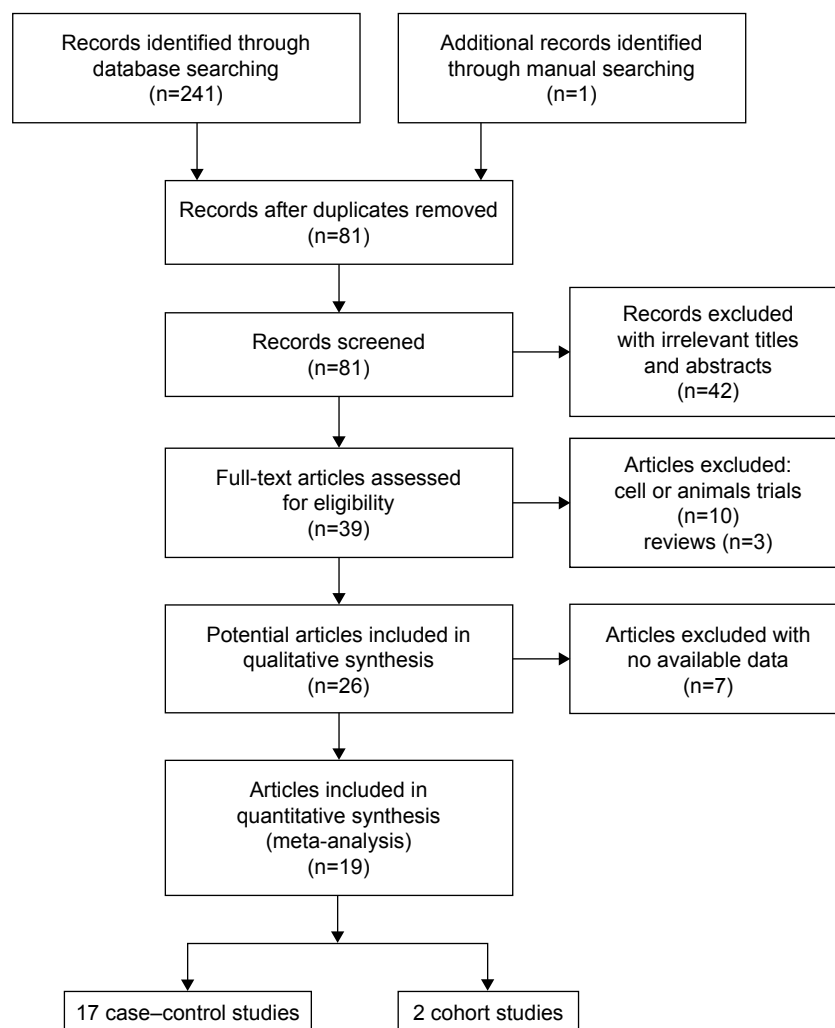

**Figure 1** Flow diagram of the selection process for this meta-analysis.

A total of 242 articles were initially retrieved from a search of six databases. After reading the titles and abstracts, 161 duplicate articles were removed, and 42 articles were excluded due to unrelated content. Based on our search criteria, 39 of the remaining articles were retrieved for detailed evaluation. Among these articles, 10 were excluded due to their focus on cell lines or animal trials, and 7 articles were eliminated for having insufficient data on *MLH1* promoter methylation. Finally, 19 articles (including 17 case–control and two cohort studies) fulfilled our inclusion criteria and were included in the meta-analysis.<sup>22,33–50</sup> Table 1 presents the basic characteristics of all eligible studies.

## Association between *MLH1* promoter methylation and EC carcinogenesis

With no obvious evidence of heterogeneity between studies (cancer vs controls:  $I^2=0\%$ ,  $P=0.45$ ; cancer vs precancerous lesions:  $I^2=0\%$ ,  $P=0.41$ ; precancerous lesions vs controls:  $I^2=0\%$ ,  $P=0.92$ ), the association between *MLH1* promoter methylation and carcinogenesis of EC was evaluated by using a fixed-effects model. A total of 15 case–control studies, the samples of which collectively included 1,237 ECs and 1,223 normal controls, were included in the current meta-analysis. Our results indicated that the frequency

of methylation of the *MLH1* promoter was significantly higher in ECs than in normal controls (OR=8.40, 95% CI =5.75–12.28,  $P<0.01$ ; Figure 2A). A subgroup analysis was conducted by ethnicity, histology, control source, detection method, sample size, and publication year. The results of this subgroup analysis showed that *MLH1* hypermethylation was significantly associated with EC in all subgroups (Table 2). Subgroup analysis by ethnicity revealed an OR of 11.90 (95% CI =2.75–51.51,  $P<0.01$ ) for Caucasian populations and 8.15 (95% CI =5.75–12.08,  $P<0.01$ ) for Asian populations. The histology subgroup analysis showed that the OR was 8.32 (95% CI =5.64–12.29,  $P<0.01$ ) for the ESCC subgroup, and it was 9.98 (95% CI =1.83–54.32,  $P<0.01$ ) for the EAC subgroup. To test the robustness of our results, a sensitivity analysis was performed to determine the influence of an individual study on overall pooled ORs. The omission of individual studies did not significantly change the pooled OR, suggesting that the results were stable and credible (Figure 3). Furthermore, a total of six studies involving 191 ECs and 262 precancerous lesions were included to evaluate the association between the methylation of *MLH1* in ECs and precancerous lesions. We observed that the methylation frequency of *MLH1* was markedly elevated in ECs compared with precancerous lesion samples (OR=3.08;

**Table 1** The basic characteristics of all eligible studies

Study	Year	Country	Ethnicity	Method	Carcinoma		Normal			Precarcinoma		NOS
					M+	Samples	M+	Samples	Source	M+	Samples	
Eads et al <sup>33</sup>	2001	USA	Caucasian	qMSP	2	22	0	31	A	1	19	7
Nie et al <sup>34</sup>	2002	China	Asian	MSP	5	21	0	25	A	2	13	7
Geddert et al <sup>35</sup>	2004	Germany	Caucasian	MSP	7	50	0	50	A	NA	NA	8
Tzao et al <sup>36</sup>	2005	China	Asian	MSP	37	60	0	20	A	NA	NA	7
Clement et al <sup>37</sup>	2006	Switzerland	Caucasian	MS-DBA	1	27	0	16	H	NA	NA	7
Guo et al <sup>38</sup>	2006	China	Asian	MSP	16	69	1	17	H	8	60	7
Ishii et al <sup>39</sup>	2007	Japan	Asian	COBRA	6	56	1	56	A	0	21	8
							0	42	H			
Wang et al <sup>40</sup>	2008	China	Asian	MSP	4	125	0	125	A	NA	NA	8
							0	10	H			
Liao et al <sup>41</sup>	2009	China	Asian	MSP	22	105	2	105	A	NA	NA	7
Moriichi et al <sup>42</sup>	2009	Japan	Asian	MSP	NA	NA	0	21	NA	7	83	7
Vasavi et al <sup>43</sup>	2010	India	African	MSRE	33	50	NA	NA	NA	NA	NA	8
Lu et al <sup>44</sup>	2011	China	Asian	MSP	4	120	0	120	A	NA	NA	8
Ling et al <sup>45</sup>	2011	China	Asian	qMSP	102	235	21	235	A	NA	NA	8
Wang et al <sup>46</sup>	2011	China	Asian	MSRE	1	13	0	55	H	0	21	7
Chen et al <sup>47</sup>	2012	China	Asian	MSP	11	257	0	257	A	NA	NA	8
Su et al <sup>22</sup>	2014	China	Asian	MSP	9	51	6	51	A	NA	NA	8
Fukui et al <sup>48</sup>	2016	Japan	Asian	MS-HRM	8	10	NA	NA	NA	29	128	8
Guilleret et al <sup>49</sup>	2016	Switzerland	Caucasian	MLM	17	26	0	8	H	NA	NA	7
Wu et al <sup>50</sup>	2017	China	Asian	MSP	53	87	NA	NA	NA	NA	NA	8

**Abbreviations:** A, autologous (control samples from the same patients); COBRA, combined bisulfite restriction analysis; H, heterogeneous (control samples from other individuals); M+, positive for *MLH1* methylation test; *MLH1*, mutL homolog-1; MLM, methylation ligation-dependent macroarray; MS-DBA, methylation-sensitive dot-blot assay; MS-HRM, methylation-sensitive high-resolution melting analyses; MSP, methylation-specific polymerase chain reaction; MSRE, methylation-sensitive restriction endonuclease; NA, not available; NOS, Newcastle–Ottawa Scale; qMSP, quantitative methylation-specific polymerase chain reaction.

95% CI =1.64–5.92;  $P < 0.01$ ; Figure 2B). The analysis of the association between *MLH1* methylation and esophageal precancerous lesions included 196 precancerous samples and 192 normal controls from five studies. As demonstrated in Figure 2C, the methylation frequency of *MLH1* was significantly higher in precancerous lesions than in controls (OR=3.75; 95% CI =1.08–13.02;  $P = 0.04$ ). The potential publication bias was assessed by Begg’s funnel plot analysis

and Egger’s test. The results indicated no significant publication bias among the studies under analysis (Figure 4).

### MLH1 promoter methylation and clinicopathological features of EC patients

We also evaluated the association between *MLH1* methylation and clinicopathological features of EC patients, including age, gender, smoking behavior, alcohol consumption,

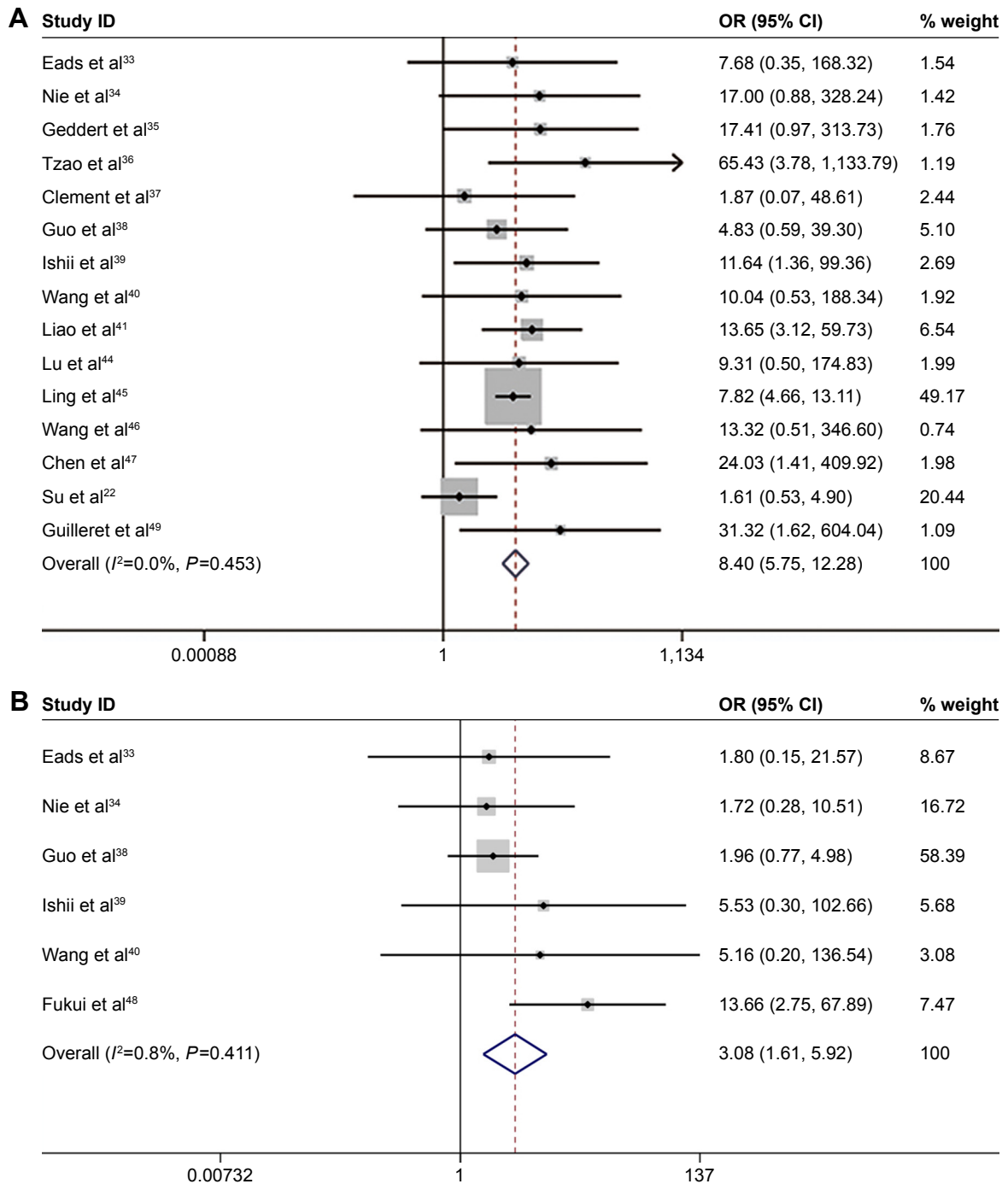
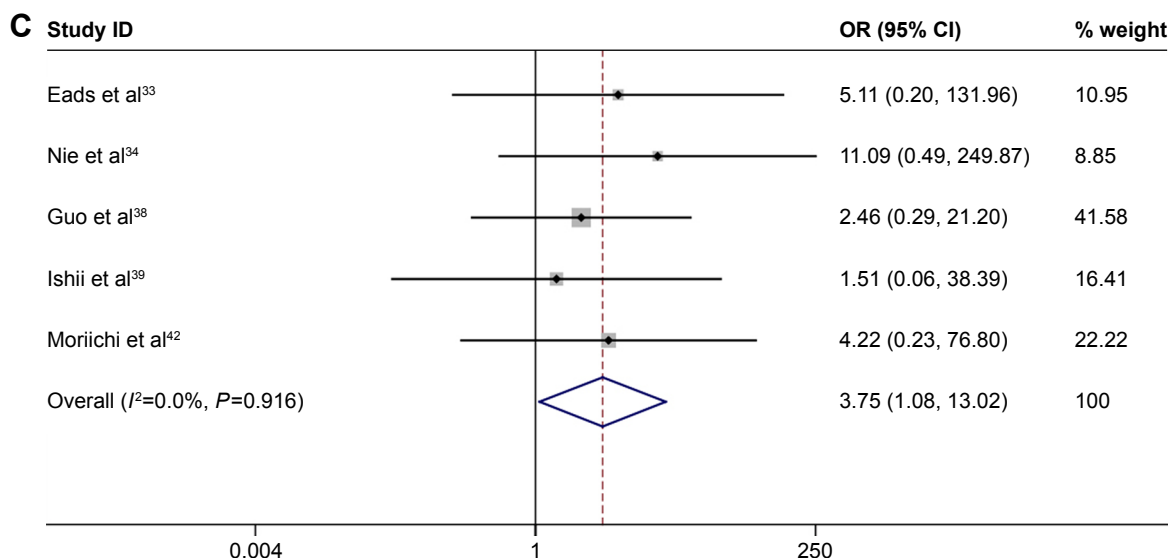

Figure 2 (Continued)



**Figure 2** Pooled forest plot of *MLHI* methylation frequency during the carcinogenesis of esophageal cancer. **Notes:** (A) Carcinoma versus healthy controls: OR=8.40, 95% CI =5.75–12.28. (B) Carcinoma versus precancerous lesions: OR=3.08; 95% CI =1.64–5.92. (C) Precancerous lesions versus healthy controls: OR=3.75; 95% CI =1.08–13.02. **Abbreviations:** *MLHI*, mutL homolog-1; OR, odds ratio.

differentiation grade, location, T stage, lymph node metastasis, distant metastasis, and clinical stage. Our analyses demonstrated that *MLHI* methylation was significantly associated with age (OR=1.79; 95% CI =1.20–2.66;  $P<0.01$ ), T grade (OR=3.7; 95% CI =2.37–5.77;  $P<0.01$ ), lymph node metastasis (OR=2.65; 95% CI =1.81–3.88;  $P<0.01$ ), distant metastasis (OR=7.60; 95% CI =1.23–47.19;  $P=0.03$ ), and clinical stage (OR=4.46; 95% CI =2.88–6.91;  $P<0.01$ ).

However, there was no correlation between *MLHI* promoter methylation and other clinicopathological characteristics of EC patients (Table 3).

### Prognostic value of *MLHI* promoter methylation for EC patients

A total of 207 EC patients from two studies<sup>44,50</sup> were involved to assess the prognostic value of *MLHI* promoter methylation.

**Table 2** Subgroup analyses of *MLHI* promoter methylation in esophageal cancer

Subgroup	Case		Control		Pooled OR (95% CI)	P-value	Heterogeneity	
	M+	Total	M+	Total			$I^2$ (%)	P-value
Ethnicity								
Caucasian	27	125	0	105	11.90 (2.75–51.51)	<0.01	0	0.62
Asian	217	1,112	31	1,118	8.15 (5.75–12.08)	<0.01	16.2	0.29
Histology								
ESCC	224	1,162	31	1,168	8.32 (5.64–12.29)	<0.01	10.6	0.34
EAC	20	75	0	55	9.98 (1.83–54.32)	<0.01	0	0.45
Control source								
Autologous	209	1,102	30	1,075	8.28 (5.58–12.29)	<0.01	15.9	0.29
Heterogeneous	28	290	1	140	6.54 (2.12–11.69)	<0.01	0	0.55
Methods								
MSP	115	858	9	780	8.61 (4.64–15.97)	<0.01	0	0.88
No MSP	129	379	22	443	8.25 (5.12–13.30)	<0.01	34.7	0.14
Sample size								
<60	48	266	7	334	5.59 (2.74–11.39)	<0.01	17	0.3
≥60	196	971	24	889	9.74 (6.21–15.27)	<0.01	0	0.75
Published year								
<2010	100	535	4	497	12.74 (5.84–27.78)	<0.01	0	0.89
≥2010	144	702	27	726	6.99 (4.52–10.82)	<0.01	42.9	0.12

**Abbreviations:** EAC, esophageal adenocarcinoma; ESCC, esophageal squamous cell carcinoma; M+, positive for *MLHI* methylation test; *MLHI*, mutL homolog-1; MSP, methylation-specific polymerase chain reaction; OR, odds ratio.

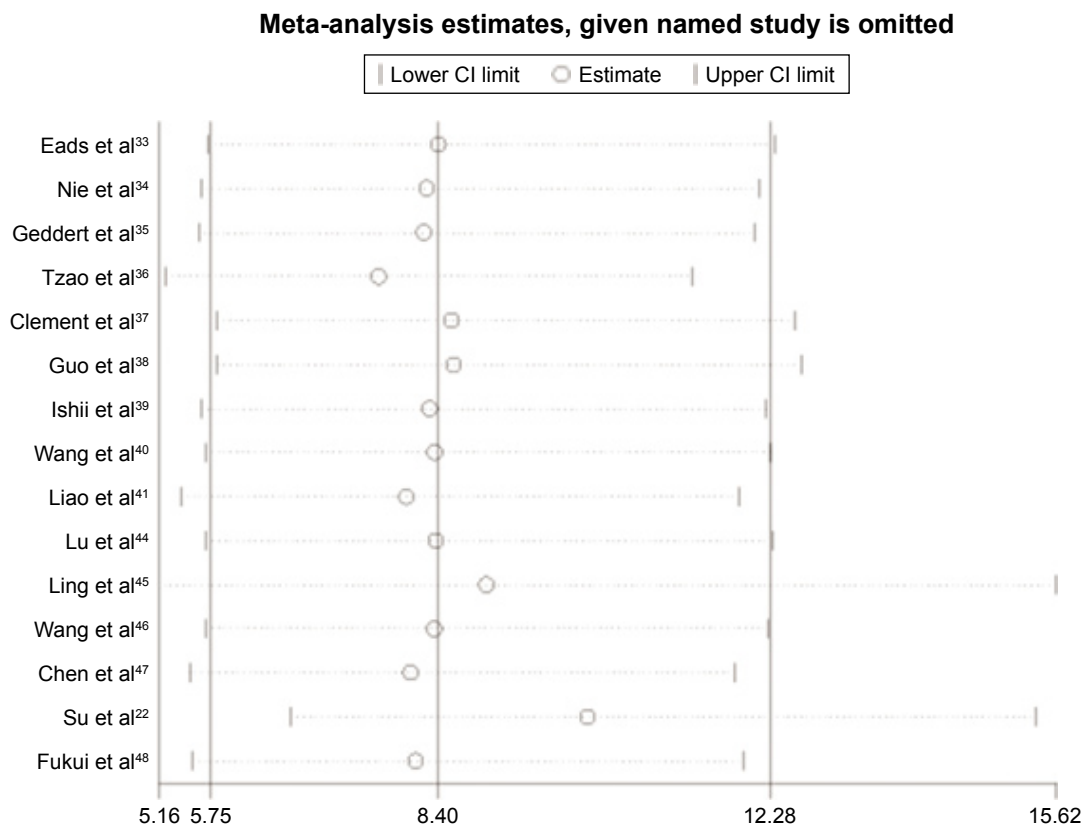

**Figure 3** Sensitivity analysis of pooled ORs for the association between *MLH1* methylation and esophageal cancer.  
**Abbreviations:** *MLH1*, mutL homolog-1; OR, odds ratio.

The results revealed that *MLH1* methylation was significantly associated with poor OS of EC patients (HR =1.64; 95% CI =1.00–2.69;  $P < 0.05$ ; Figure 5). More studies with larger sample sizes are necessary to further validate the prognostic value of *MLH1* promoter methylation in the future.

### Diagnostic value of *MLH1* promoter methylation for EC patients

We further calculated the pooled sensitivity, specificity, and AUC and performed Fagan plot analysis from 15 case-control studies to evaluate the diagnostic value of *MLH1* promoter methylation for EC patients. The pooled sensitivity, specificity, and AUC values were 0.15 (95% CI =0.08–0.25), 0.99 (95% CI =0.97–1.00), and 0.77 (95% CI =0.73–0.81), respectively (Figure 6). As shown in Figure 7, the pretest probability values of being diagnosed with EC were defined as 25%, 50%, and 75%, respectively. The analysis demonstrated that the probabilities of a patient being diagnosed with EC were 89%, 96%, and 99%, respectively, if the *MLH1* promoter methylation detection result was positive. When the test was negative, the patient had a 22%, 46%, and 72% possibility of having EC, respectively.

### Discussion

EC is one of the most fatal digestive tract malignancies, representing the eighth leading cause of cancer-related deaths worldwide.<sup>51</sup> Without effective early diagnosis biomarkers and therapeutic strategies, the prognosis of EC is relatively poor, with a 5-year survival rate of <20%, although it may be variable in different histotypes.<sup>52</sup> Aberrant DNA methylation in the TSG promoter has been identified as an important mechanism of tumorigenesis and progression of several cancers, including cervical cancer,<sup>10</sup> oral cancer,<sup>53</sup> and colorectal cancer.<sup>54</sup> In addition, as a relatively early molecular change, aberrant methylation was reported to be a potential biomarker for early cancer diagnosis.<sup>55</sup>

The *MLH1* gene is a critical component of the DNA MMR system and has been considered to play an essential role in maintaining genomic stability.<sup>15</sup> Several previous studies evaluated whether *MLH1* promoter methylation is associated with EC risk, but the results of these studies were inconsistent because of the use of different histotypes, control types, population ethnicities, and detection methods.<sup>40,45</sup> Therefore, we conducted a meta-analysis to assess the association between *MLH1* promoter methylation and EC carcinogenesis. The overall OR of *MLH1* promoter methylation frequency was

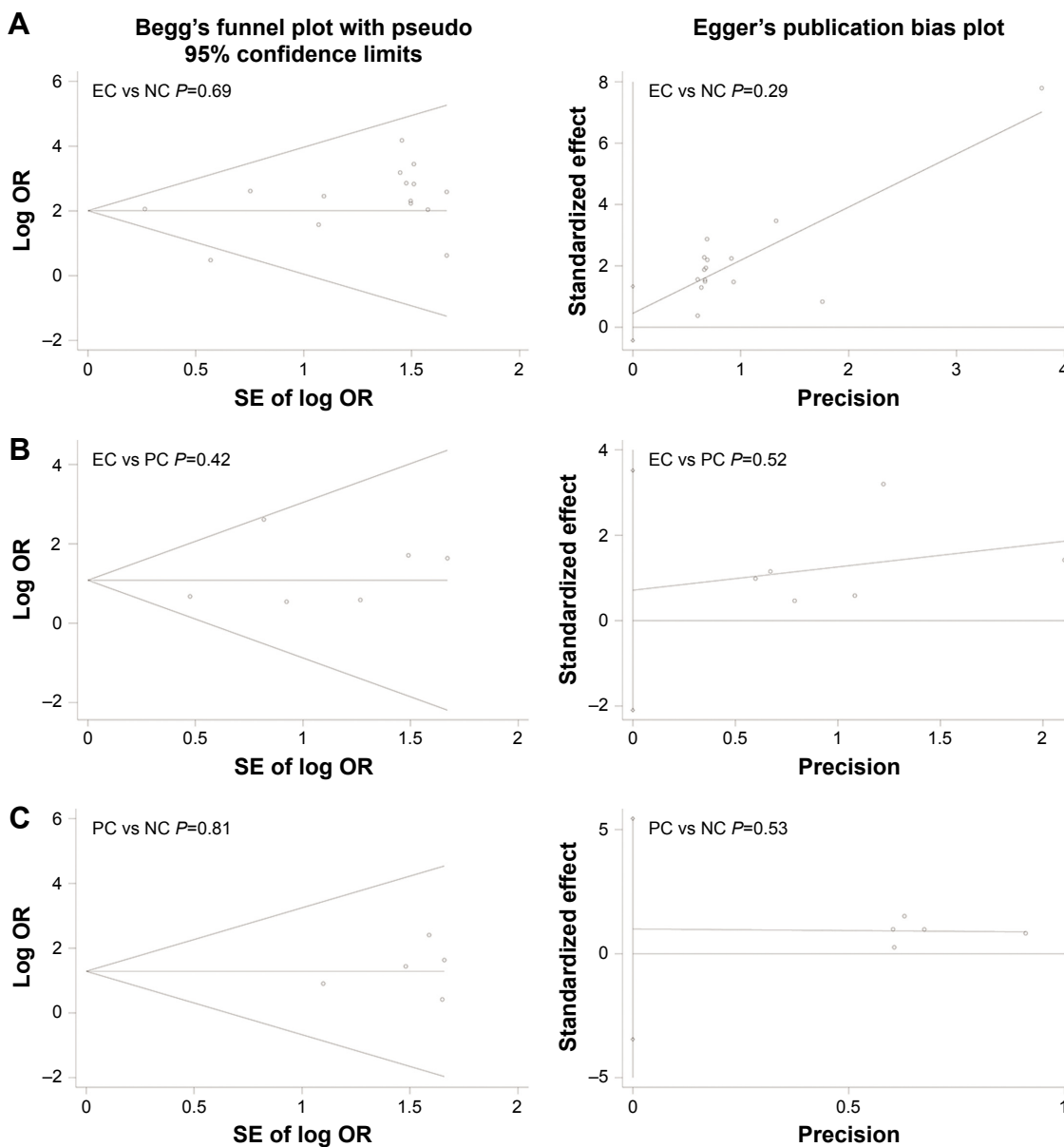

**Figure 4** Begg's funnel plots and Egger's test of publication bias for *MLH1* methylation during the carcinogenesis of esophageal cancer.

**Notes:** (A) Carcinoma versus healthy controls: Begg's test:  $P=0.69$ ; Egger's test:  $P=0.29$ . (B) Carcinoma versus precancerous lesions: Begg's test:  $P=0.42$ ; Egger's test:  $P=0.52$ . (C) Precancerous lesions versus healthy controls: Begg's test:  $P=0.81$ ; Egger's test:  $P=0.53$ .

**Abbreviations:** EC, esophageal cancer; *MLH1*, mutL homolog-1; NC, normal control; PC, precancerous lesions.

**Table 3** Association between *MLH1* promoter methylation and clinicopathological features of esophageal cancer patients

Characteristics	No	Case/control	Pooled OR (95% CI)	P-value	Heterogeneity	
					I <sup>2</sup> %	P-value
Age	4	Older/younger	1.79 (1.20–2.66)	<0.01	0	0.4
Gender	4	Male/female	1.12 (0.61–2.05)	0.71	0	0.99
Smoking behavior	3	Yes/no	0.90 (0.46–1.74)	0.75	0	0.78
Alcohol consumption	3	Yes/no	0.81 (0.42–1.57)	0.54	0	0.73
Differentiation grade	4	Poor/well and moderate	1.45 (0.92–2.28)	0.11	26.7	0.25
Location	4	Up and middle/down	0.87 (0.58–1.31)	0.5	0	0.9
T stage	6	T <sub>3+4</sub> /T <sub>1+2</sub>	3.7 (2.37–5.77)	<0.01	78.8	<0.01
Lymph node metastasis	6	Yes/no	2.65 (1.81–3.88)	<0.01	73.2	<0.01
Distant metastasis	4	Yes/no	7.60 (1.23–47.19)	0.03	63.6	0.04
Clinical stage	4	III + IV/I + II	4.46 (2.88–6.91)	<0.01	88.9	<0.01

**Abbreviations:** *MLH1*, mutL homolog-1; No, number of studies; OR, odds ratio.



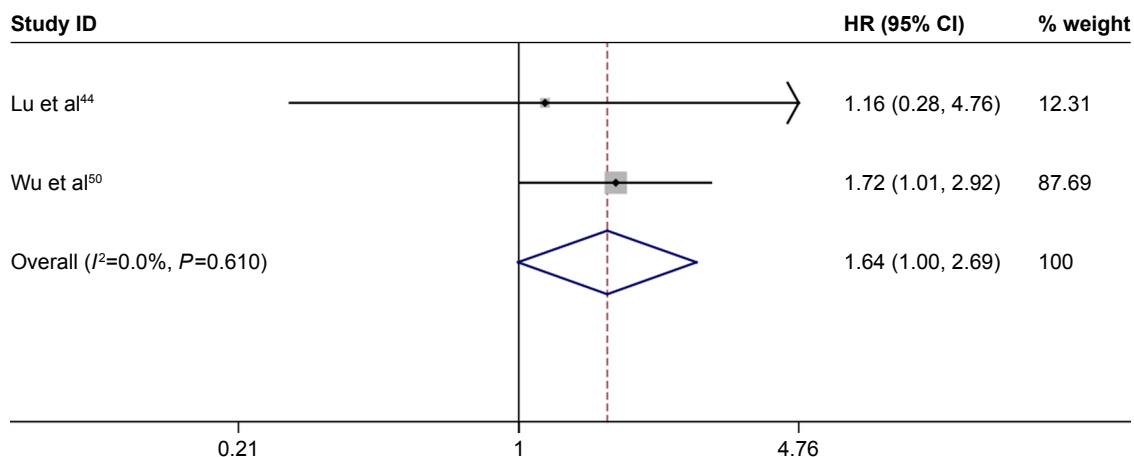

**Figure 5** Forest plot for pooled HR and the corresponding 95% CI of *MLHI* methylation for OS of EC patients.

**Abbreviations:** EC, esophageal cancer; HR, hazard ratio; *MLHI*, mutL homolog-I; OR, odds ratio; OS, overall survival.

higher in EC tissues than in control tissues, which is consistent with the results found for other types of carcinomas.<sup>56</sup> The sensitivity analysis and the absence of heterogeneity indicate that our results were stable and credible. Moreover, the subgroup analysis based on ethnicity revealed that the OR of the association between *MLHI* methylation and EC was higher for Caucasian populations than for Asian populations, indicating that the Caucasian population may be more susceptible to *MLHI* promoter methylation. The majority of ECs can be subdivided into two main histological subtypes: adenocarcinomas and squamous cell carcinomas. Previous studies have demonstrated the molecular separation between ESCC and EAC, showing that ESCC has a stronger

resemblance to head and neck squamous cell carcinoma than to EAC and that EAC more closely resembled gastric cancer than ESCC.<sup>57</sup> In this study, the subgroup analysis of histology indicated that the OR of the EAC subgroup was greater than that of the ESCC subgroup, indicating that the methylated *MLHI* gene may be used to distinguish the histotype of EC. EC is a complicated and progressive disease. EAC originates predominantly from BE, and dysplasia is the precursor for both EAC and ESCC.<sup>5</sup> Our analysis showed that the methylation level of the *MLHI* promoter was also significantly higher in EC than in premalignant lesions. Moreover, the frequency of *MLHI* methylation was markedly higher in premalignant lesions than in healthy controls. These results collectively indicate that hypermethylation of the *MLHI* promoter is involved in the onset and carcinogenesis of EC.

Furthermore, we evaluated the relationship between *MLHI* methylation and the clinicopathological parameters of EC. Age is believed to be an important cancer-related risk factor, and EC occurs mostly in patients aged >50 years, with a median age of 68 years.<sup>7</sup> Our findings revealed that *MLHI* promoter methylation was more likely to occur in elderly patients, which may account for the finding that patients aged >60 years showed a rapid increase in EC.<sup>7</sup> In addition, our analysis demonstrated that the frequency of *MLHI* promoter methylation was significantly elevated in advanced T grade, lymph node metastasis, distant metastasis, and advanced clinical stage EC patients, suggesting that *MLHI* promoter methylation may play a critical role in EC progression and metastasis. However, there was no correlation between *MLHI* promoter methylation and other clinicopathological characteristics of EC patients. We also investigated whether *MLHI* promoter hypermethylation was correlated with the prognosis of EC patients, based on the prediction of OS using multivariate analysis.

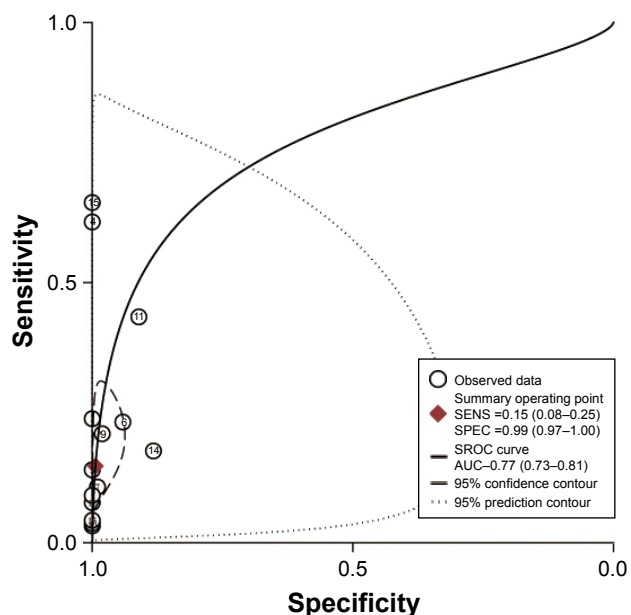

**Figure 6** SROC plots of methylated *MLHI* for the diagnosis of esophageal cancer.

**Abbreviations:** *MLHI*, mutL homolog-I; SENS, sensitivity; SPEC, specificity; SROC, summary of receiver operating characteristic.

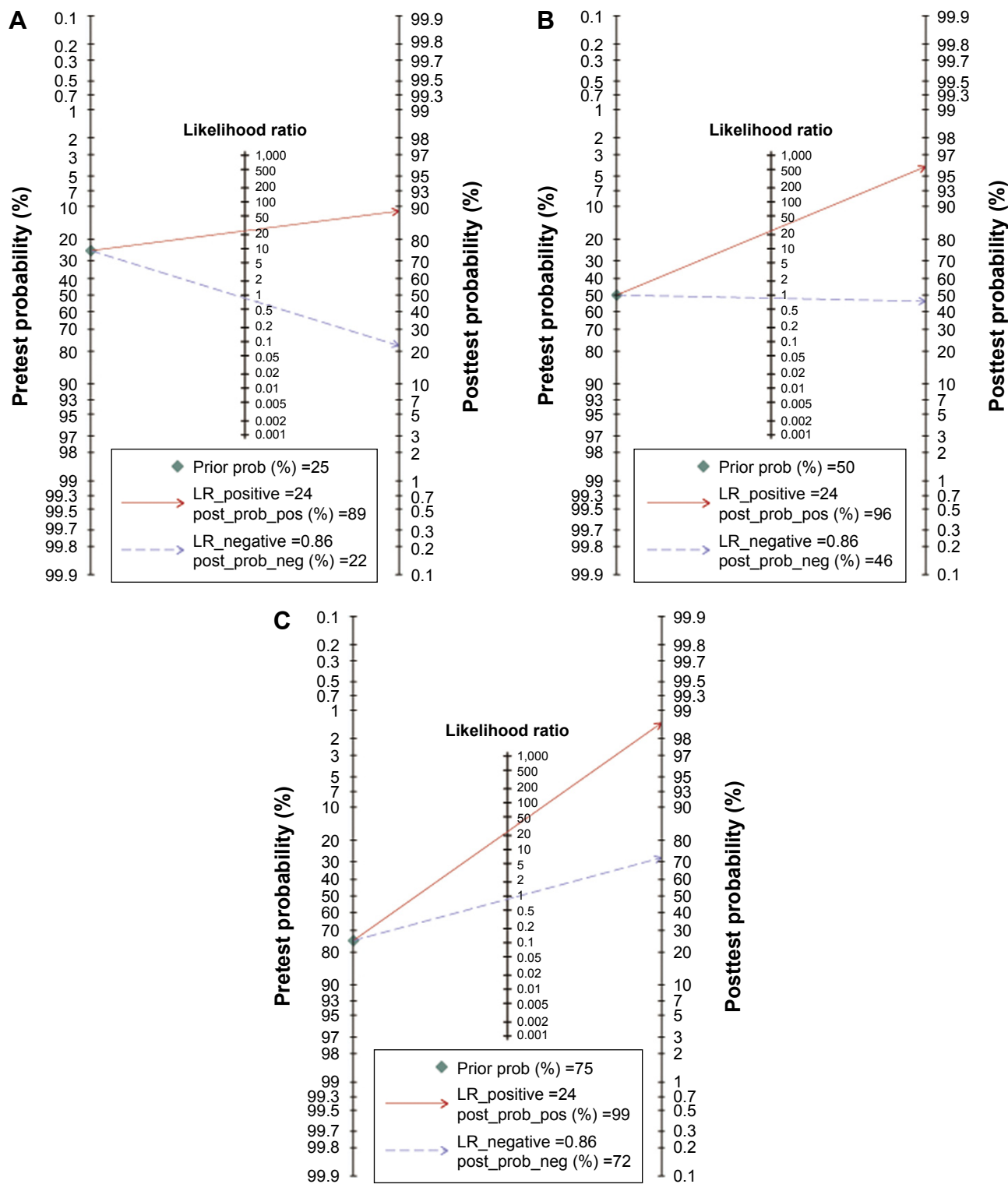

**Figure 7** Fagan plot analysis to evaluate the diagnostic power of methylated *MLH1* for esophageal cancer.

**Notes:** (A) The posttest probability was 89% at a pretest probability of 25%. (B) The posttest probability was 96% at a pretest probability of 50%. (C) The posttest probability was 99% at a pretest probability of 75%.

**Abbreviations:** LR, likelihood ratio; *MLH1*, mutL homolog-1.

The results revealed that compared with EC patients with *MLH1* promoter hypomethylation, those with *MLH1* promoter hypermethylation had a 1.64-fold higher risk of poor OS, indicating that hypermethylation of the *MLH1* promoter

is a potential prognosis biomarker for EC patients. However, more studies are needed to confirm and further clarify this finding, as only 207 EC patients were analyzed in the present study.

Abnormal methylation biomarkers have proven to be useful in diagnosing numerous cancers.<sup>58,59</sup> Hence, we evaluated the diagnostic effect of *MLH1* promoter methylation for EC based on 15 studies of EC versus healthy subjects. The *MLH1* methylation test exhibited a pooled sensitivity of 0.15, a specificity of 0.99, and an AUC of 0.77, indicating that *MLH1* promoter methylation has a moderate diagnostic accuracy for EC. *MLH1* promoter methylation alone may not be suitable for screening and diagnosing EC, due to its low sensitivity. However, given its near-perfect specificity, *MLH1* promoter methylation is a potential diagnostic biomarker for EC if combined with other diagnostic technologies, which we confirmed using Fagan plot analysis. The Fagan plot analysis demonstrated that if the pretest probabilities were assumed to be 25%, 50%, and 75%, then 89%, 96%, and 99% of patients would be correctly diagnosed with EC following positive *MLH1* methylation tests, suggesting that methylated *MLH1* has effective diagnostic power to distinguish EC patients from healthy individuals. More rigorously designed studies with larger sample sizes are essential to validate our findings.

However, there were several limitations of our meta-analysis that should be noted. First, only articles published in English and Chinese were included in the study, which may have contributed to selection bias. Second, most studies were conducted in Asian and Caucasian populations, while other ethnic groups, such as Africans, were underrepresented. Third, because there were relatively few studies describing the association between *MLH1* promoter methylation and clinicopathological parameters and OS, studies with larger sample sizes are needed to validate our findings. These studies should also be included in a future-updated meta-analysis to support the findings of the present study.

## Conclusion

This integrated analysis provided a strong evidence that *MLH1* methylation is significantly associated with the carcinogenesis, progression, and metastasis of EC. In addition, methylated *MLH1* is a promising biomarker for the diagnosis and prognosis of EC. Future research with larger sample sizes and strong study designs is essential to confirm our results.

## Acknowledgments

This research was supported by grants from the Zhejiang Provincial Natural Science Foundation of China (No. LY16H160005), the Project of Scientific Innovation Team of Ningbo (No. 2015B11050), and the Ningbo Natural Science Foundation (No. 2014A610235, 2015A610221, and 2017A610236).

## Author contributions

All authors contributed toward data analysis, drafting and revising the paper and agree to be accountable for all aspects of the work.

## Disclosure

The authors report no conflicts of interest in this work.

## References

- Zhang Y. Epidemiology of esophageal cancer. *World J Gastroenterol*. 2013;19(34):5598–5606.
- Domper Arnal MJ, Ferrandez Arenas A, Lanás Arbeloa A. Esophageal cancer: risk factors, screening and endoscopic treatment in Western and Eastern countries. *World J Gastroenterol*. 2015;21(26):7933–7943.
- Grundy A, Poirier AE, Khandwala F, McFadden A, Friedenreich CM, Brenner DR. Cancer incidence attributable to alcohol consumption in Alberta in 2012. *CMAJ Open*. 2016;4(3):E507–E514.
- Liang H, Fan JH, Qiao YL. Epidemiology, etiology, and prevention of esophageal squamous cell carcinoma in China. *Cancer Biol Med*. 2017;14(1):33–41.
- Arnold M, Soerjomataram I, Ferlay J, Forman D. Global incidence of oesophageal cancer by histological subtype in 2012. *Gut*. 2015;64(3):381–387.
- Rutegard M, Charonis K, Lu Y, Lagergren P, Lagergren J, Rouvelas I. Population-based esophageal cancer survival after resection without neoadjuvant therapy: an update. *Surgery*. 2012;152(5):903–910.
- Bollschweiler E, Plum P, Monig SP, Holscher AH. Current and future treatment options for esophageal cancer in the elderly. *Expert Opin Pharmacother*. 2017;18:1001–1010.
- Spechler SJ. Clinical practice. Barrett's Esophagus. *N Engl J Med*. 2002;346(11):836–842.
- Ahrens TD, Werner M, Lassmann S. Epigenetics in esophageal cancers. *Cell Tissue Res*. 2014;356(3):643–655.
- Li J, Zhou C, Zhou H, et al. The association between methylated CDKN2A and cervical carcinogenesis, and its diagnostic value in cervical cancer: a meta-analysis. *Ther Clin Risk Manag*. 2016;12:1249–1260.
- Zhang C, Li J, Huang T, et al. Meta-analysis of DNA methylation biomarkers in hepatocellular carcinoma. *Oncotarget*. 2016;7(49):81255–81267.
- Shen Z, Zhou C, Li J, Deng H, Li Q, Wang J. The association, clinicopathological significance, and diagnostic value of CDH1 promoter methylation in head and neck squamous cell carcinoma: a meta-analysis of 23 studies. *Oncotargets Ther*. 2016;9:6763–6773.
- Kaz AM, Wong CJ, Luo Y, et al. DNA methylation profiling in Barrett's esophagus and esophageal adenocarcinoma reveals unique methylation signatures and molecular subclasses. *Epigenetics*. 2011;6(12):1403–1412.
- Arantes LM, de Carvalho AC, Melendez ME, Carvalho AL, Goloni-Bertollo EM. Methylation as a biomarker for head and neck cancer. *Oral Oncol*. 2014;50(6):587–592.
- Larrea AA, Lujan SA, Kunkel TA. SnapShot: DNA mismatch repair. *Cell*. 2010;141(4):730.e1.
- Kenyon J, Nickel-Meester G, Qing Y, et al. Epigenetic loss of MLH1 expression in normal human hematopoietic stem cell clones is defined by the promoter CpG methylation pattern observed by high-throughput methylation specific sequencing. *Int J Stem Cell Res Ther*. 2016;3(2):pii:031.
- Zhao JX, Li XW, Shi BY, et al. Effect of histone modifications on hMLH1 alternative splicing in gastric cancer. *Tumour Biol*. 2017;39(4):1010428317697546.
- Pastuszak-Lewandoska D, Kordiak J, Antczak A, et al. Expression level and methylation status of three tumor suppressor genes, DLEC1, ITGA9 and MLH1, in non-small cell lung cancer. *Med Oncol*. 2016;33(7):75.

19. Ma Y, Chen Y, Petersen I. Expression and promoter DNA methylation of MLH1 in colorectal cancer and lung cancer. *Pathol Res Pract*. 2017;213(4):333–338.
20. Liu L, Yang X. Implication of Reprimo and hMLH1 gene methylation in early diagnosis of gastric carcinoma. *Int J Clin Exp Pathol*. 2015; 8(11):14977–14982.
21. Sinha S, Chunder N, Mukherjee N, et al. Frequent deletion and methylation in SH3GL2 and CDKN2A loci are associated with early- and late-onset breast carcinoma. *Ann Surg Oncol*. 2008;15(4):1070–1080.
22. Su Y, Yin L, Liu R, et al. Promoter methylation status of MGMT, hMSH2, and hMLH1 and its relationship to corresponding protein expression and TP53 mutations in human esophageal squamous cell carcinoma. *Med Oncol*. 2014;31(2):784.
23. Stang A. Critical evaluation of the Newcastle-Ottawa scale for the assessment of the quality of nonrandomized studies in meta-analyses. *Eur J Epidemiol*. 2010;25(9):603–605.
24. Higgins JP, Thompson SG. Quantifying heterogeneity in a meta-analysis. *Stat Med*. 2002;21(11):1539–1558.
25. Zintzaras E, Ioannidis JP. HEGESMA: genome search meta-analysis and heterogeneity testing. *Bioinformatics*. 2005;21(18):3672–3673.
26. DerSimonian R, Laird N. Meta-analysis in clinical trials revisited. *Contemp Clin Trials*. 2015;45(Pt A):139–145.
27. Mantel N, Haenszel W. Statistical aspects of the analysis of data from retrospective studies of disease. *J Natl Cancer Inst*. 1959;22(4): 719–748.
28. Lau J, Ioannidis JP, Schmid CH. Quantitative synthesis in systematic reviews. *Ann Intern Med*. 1997;127(9):820–826.
29. Peters JL, Sutton AJ, Jones DR, Abrams KR, Rushton L. Comparison of two methods to detect publication bias in meta-analysis. *JAMA*. 2006;295(6):676–680.
30. Begg CB, Mazumdar M. Operating characteristics of a rank correlation test for publication bias. *Biometrics*. 1994;50(4):1088–1101.
31. Deville WL, Buntinx F, Bouter LM, et al. Conducting systematic reviews of diagnostic studies: didactic guidelines. *BMC Med Res Methodol*. 2002;2:9.
32. Fagan TJ. Letter: nomogram for Bayes theorem. *N Engl J Med*. 1975; 293(5):257.
33. Eads CA, Lord RV, Wickramasinghe K, et al. Epigenetic patterns in the progression of esophageal adenocarcinoma. *Cancer Res*. 2001;61(8): 3410–3418.
34. Nie Y, Liao J, Zhao X, et al. Detection of multiple gene hypermethylation in the development of esophageal squamous cell carcinoma. *Carcinogenesis*. 2002;23(10):1713–1720.
35. Geddert H, Kiel S, Iskender E, et al. Correlation of hMLH1 and HPP1 hypermethylation in gastric, but not in esophageal and cardiac adenocarcinoma. *Int J Cancer*. 2004;110(2):208–211.
36. Tzao C, Hsu HS, Sun GH, et al. Promoter methylation of the hMLH1 gene and protein expression of human mutL homolog 1 and human mutS homolog 2 in resected esophageal squamous cell carcinoma. *J Thorac Cardiovasc Surg*. 2005;130(5):1371.
37. Clement G, Braunschweig R, Pasquier N, Bosman FT, Benhattar J. Methylation of APC, TIMP3, and TERT: a new predictive marker to distinguish Barrett's oesophagus patients at risk for malignant transformation. *J Pathol*. 2006;208(1):100–107.
38. Guo M, Ren J, House MG, Qi Y, Brock MV, Herman JG. Accumulation of promoter methylation suggests epigenetic progression in squamous cell carcinoma of the esophagus. *Clin Cancer Res*. 2006;12(15): 4515–4522.
39. Ishii T, Murakami J, Notohara K, et al. Oesophageal squamous cell carcinoma may develop within a background of accumulating DNA methylation in normal and dysplastic mucosa. *Gut*. 2007;56(1):13–19.
40. Wang J, Sasco AJ, Fu C, et al. Aberrant DNA methylation of P16, MGMT, and hMLH1 genes in combination with MTHFR C677T genetic polymorphism in esophageal squamous cell carcinoma. *Cancer Epidemiol Biomarkers Prev*. 2008;17(1):118–125.
41. Liao L, Xiang J, Zhang Y, Huang D, Shen Z. Promoter methylation and its significance of hMLH1, E-cadherin and p16INK4a gene in esophageal squamous cell carcinoma. *China Oncol*. 2009;5:340–346.
42. Moriichi K, Watari J, Das KM, et al. Effects of Helicobacter pylori infection on genetic instability, the aberrant CpG island methylation status and the cellular phenotype in Barrett's esophagus in a Japanese population. *Int J Cancer*. 2009;124(6):1263–1269.
43. Vasavi M, Kiran V, Ravishankar B, Prabhakar B, Ahuja YR, Hasan Q. Microsatellite instability analysis and its correlation with hMLH1 repair gene hypermethylation status in esophageal pathologies including cancers. *Cancer Biomark*. 2010;7(1):1–10.
44. Lu C, Xie H, Wang F, Shen H, Wang J. Diet folate, DNA methylation and genetic polymorphisms of MTHFR C677T in association with the prognosis of esophageal squamous cell carcinoma. *BMC Cancer*. 2011;11:91.
45. Ling ZQ, Li P, Ge MH, et al. Aberrant methylation of different DNA repair genes demonstrates distinct prognostic value for esophageal cancer. *Dig Dis Sci*. 2011;56(10):2992–3004.
46. Wang F, Xie XJ, Piao YS, Liu B, Wang LD. [Methylation of p16 and hMLH1 genes in esophageal squamous cell carcinoma and reflux esophagitis]. *Zhonghua Bing Li Xue Za Zhi*. 2011;40(8):537–541. Chinese.
47. Chen J, Huang ZJ, Duan YQ, Xiao XR, Jiang JQ, Zhang R. Aberrant DNA methylation of P16, MGMT, and hMLH1 genes in combination with MTHFR C677T genetic polymorphism and folate intake in esophageal squamous cell carcinoma. *Asian Pac J Cancer Prev*. 2012; 13(10):5303–5306.
48. Fukui S, Watari J, Tomita T, et al. Localization of specialized intestinal metaplasia and the molecular alterations in Barrett esophagus in a Japanese population: an analysis of biopsy samples based on the "Seattle" biopsy protocol. *Human Pathol*. 2016;51:32–40.
49. Guilleret I, Losi L, Chelbi ST, et al. DNA methylation profiling of esophageal adenocarcinoma using Methylation Ligation-dependent Macroarray (MLM). *Biochem Biophys Res Commun*. 2016;479(2):231–237.
50. Wu D, Chen X, Xu Y, et al. Prognostic value of MLH1 promoter methylation in male patients with esophageal squamous cell carcinoma. *Oncol Lett*. 2017;13(4):2745–2750.
51. Siegel RL, Miller KD, Jemal A. Cancer statistics, 2016. *CA Cancer J Clin*. 2016;66(1):7–30.
52. Miller KD, Siegel RL, Lin CC, et al. Cancer treatment and survivorship statistics, 2016. *CA Cancer J Clin*. 2016;66(4):271–289.
53. Jayaprakash C, Varghese VK, Bellampalli R, et al. Hypermethylation of death-associated protein kinase (DAPK1) and its association with oral carcinogenesis – an experimental and meta-analysis study. *Arch Oral Biol*. 2017;80:117–129.
54. Ye M, Huang T, Li J, et al. Role of CDH13 promoter methylation in the carcinogenesis, progression, and prognosis of colorectal cancer: A systematic meta-analysis under PRISMA guidelines. *Medicine*. 2017;96(4):e5956.
55. Trujillo KA, Jones AC, Griffith JK, Bisoffi M. Markers of field cancerization: proposed clinical applications in prostate biopsies. *Prostate Cancer*. 2012;2012:302894.
56. Li X, Yao X, Wang Y, et al. MLH1 promoter methylation frequency in colorectal cancer patients and related clinicopathological and molecular features. *PLoS One*. 2013;8(3):e59064.
57. Cancer Genome Atlas Research Network; Analysis Working Group; Asan University; BC Cancer Agency; et al. Integrated genomic characterization of oesophageal carcinoma. *Nature*. 2017;541(7636): 169–175.
58. Shan M, Yin H, Li J, et al. Detection of aberrant methylation of a six-gene panel in serum DNA for diagnosis of breast cancer. *Oncotarget*. 2016;7(14):18485–18494.
59. Yang Q, Huang T, Ye G, Wang B, Zhang X. Methylation of SFRP2 gene as a promising noninvasive biomarker using feces in colorectal cancer diagnosis: a systematic meta-analysis. *Sci Rep*. 2016;6:33339.

**OncoTargets and Therapy**

Dovepress

**Publish your work in this journal**

OncoTargets and Therapy is an international, peer-reviewed, open access journal focusing on the pathological basis of all cancers, potential targets for therapy and treatment protocols employed to improve the management of cancer patients. The journal also focuses on the impact of management programs and new therapeutic agents and protocols on

Submit your manuscript here: <http://www.dovepress.com/oncotargets-and-therapy-journal>

patient perspectives such as quality of life, adherence and satisfaction. The manuscript management system is completely online and includes a very quick and fair peer-review system, which is all easy to use. Visit <http://www.dovepress.com/testimonials.php> to read real quotes from published authors.